

封底空白页

QUICK START GUIDE

Read this manual carefully and save it for future reference.

Lisez attentivement ce manuel et conservez-le pour référence future.

Lea este manual con atención y guárdelo para futuras consultas.

GET BETTER SECURITY WITH Cam Plus

Record Full-Length Videos

Get unlimited full-length video recordings.

Smart AI Detection

Detect people, packages, vehicles, and more.

Back-to-Back Event Recording

Capture everything without 5-minute gaps.

Exclusive Discounts

Get exclusive discounts on Wyze products.

Subscribe or learn more at services.wyze.com.

Welcome to Wyze!

Hi! Thanks for getting your hands on a Wyze Cam Floodlight v2, and if this is your first Wyze product, welcome to the Wyze family! You just made a commitment to a better, more connected lifestyle.

Please read this guide carefully before setting up the device, and keep it in a safe place for future reference.

IN THE BOX

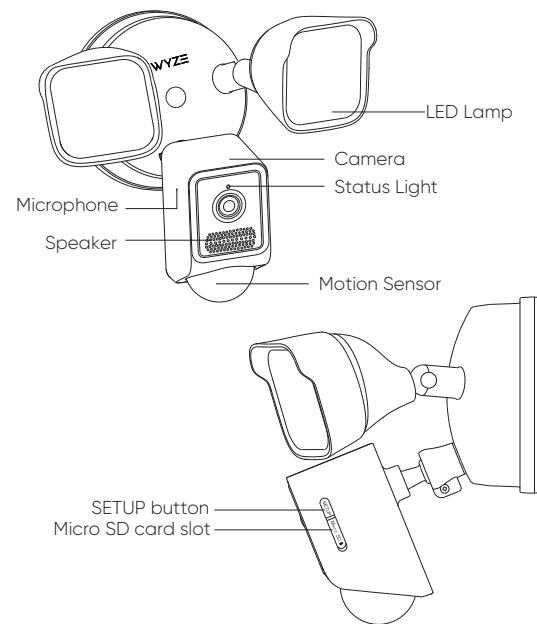
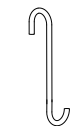
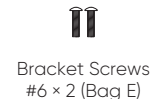

Disclaimer: The products, accessories, user interfaces, etc. illustrated in this guide are intended for reference only. Due to product updates, the actual product and the illustrations in this guide may vary.

Clause de non-responsabilité : Les produits, accessoires, interfaces utilisateur, etc. illustrés dans ce guide sont destinés à servir de référence uniquement. En raison des mises à jour des produits, le produit réel et les illustrations de ce guide peuvent varier.

Descargo de responsabilidad: Los productos, accesorios, interfaces de usuario, etc. que se ilustran en esta guía son sólo de referencia. Debido a las actualizaciones del producto, el producto real y las ilustraciones de esta guía pueden variar.

Assembled Wyze Cam Floodlight v2 Camera x 1

SETUP

- 1 Download the Wyze app and sign in or create an account.
- 2 Select **Add Device > Cameras > Wyze Cam Floodlight v2** and follow the instructions in the app.
- 3 Check your local laws for installation. If you are outside of North America, installation and wiring must be performed by a licensed electrician. Make sure you follow all code standards when doing wire installation.
- 4 **WARNING: Risk of electrical shock!**



1. Make sure you have a junction box for your floodlight installation. If you need one installed, please contact a licensed electrician.
2. Verify that the power supply is a 120 V AC 60 Hz power source.
3. Disconnect power using the fuse or circuit breaker before continuing.

Notes: Do not use a dimmer switch or timer for this product.
Apply caulk to mounting surface on all sides to ensure complete waterproofing.



You can mount the floodlight vertically on the wall or overhang under eaves.

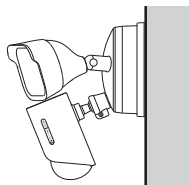

WALL MOUNT
(refer to pages 2-5)

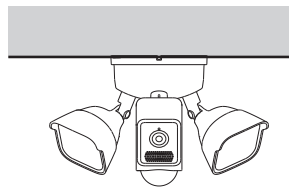

EAVE MOUNT
(refer to pages 5-7)

WALL MOUNT

Recommended Installation Location

Tip: When Wyze Cam Floodlight v2 is mounted 10 feet above the ground, it will detect motion up to 30 feet away.

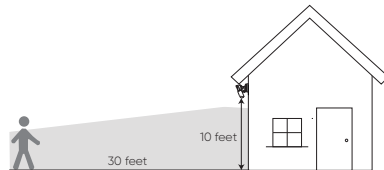

2

- 1 Take your Wyze Cam Floodlight v2 out of the box and rotate the camera 180° so that the Wyze logo is at the top and the motion sensor is pointed down.

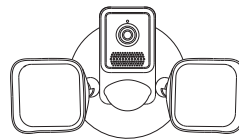

1 Starting position

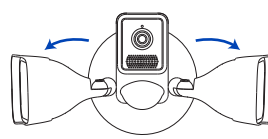

2 Tilt lights down

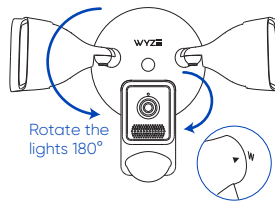

Rotate the lights 180°

3 Rotate the lights and camera 180°

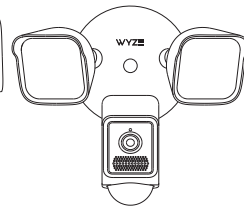

4 Tilt lights up

Important: While positioning the camera for wall installation, find the "W" and arrows on the joint arm behind the camera. Make sure the arrows are in alignment. **Do not** rotate the camera completely around as this may twist or break the connection line.

- 2 Remove your existing floodlight and any brackets that may be attached if you are replacing a previous product.
- 3 Place the mounting bracket on the junction box. Align the 2 screw holes and tighten the bracket using matching bracket screws (Bag C, D, or E).

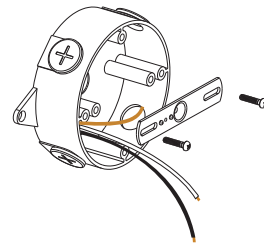

Junction Box

Note: If you don't have a junction box, please find a licensed electrician to install one and follow local building codes.

3

- 4 Use the ground wire screw (Bag A) to attach the ground wire to the middle of the mounting bracket.

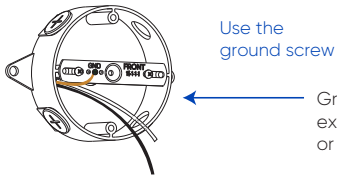

- 5 Hang the floodlight on the mounting bracket using the provided hook as shown in the picture.

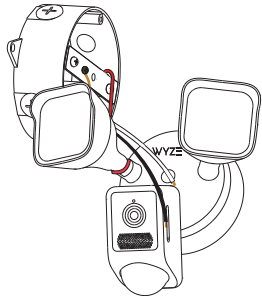

- 6 Connect the hot wire (usually black) from your floodlight to the hot wire from your junction box. Then connect the 2 neutral wires (usually white). Cap the wires using wire nuts and twist them 5-10 times. Gently tug on the wire nut to make sure it's securely attached.

IMPORTANT: If you are not sure which wire is which, please consult an electrician for safety.

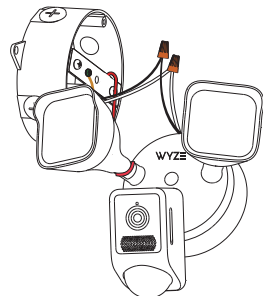
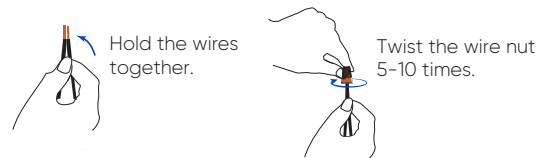

- 7 Push the wires back into the junction box. **Make sure the wires are not pinched between Wyze Cam Floodlight v2 and the mounting bracket.**

- 8 Screw your Wyze Cam Floodlight v2 to the mounting bracket using the floodlight screw (Bag B).

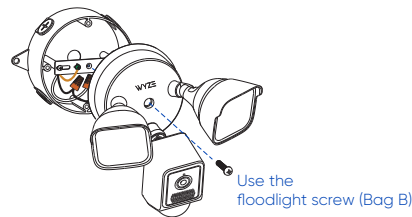

- 9 Place the rubber stopper over the floodlight screw to protect the screw.

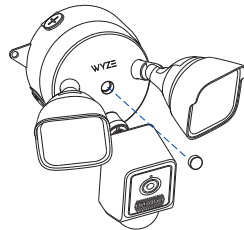

- 10 Adjust the angle of the motion sensor so it is parallel to the ground.

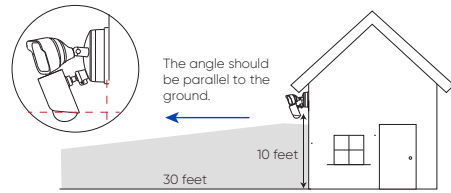

EAVE MOUNT

Recommended Installation Location

Tip: When Wyze Cam Floodlight v2 is mounted 10 feet above the ground, it will detect motion up to 30 feet away.

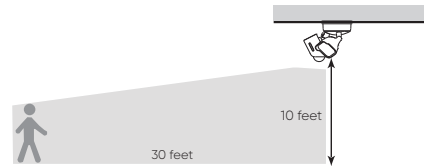

- 1 Take your Wyze Cam Floodlight v2 out of the box. Raise the LED lamps to the highest position first and then rotate it 180° to lower the LED lamp.

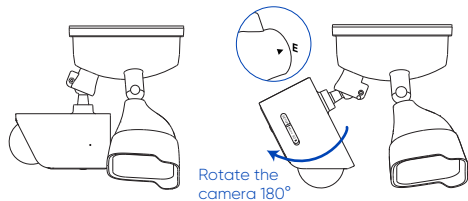

Rotate the camera 180°

- 1 Starting position

- 2 Rotate the camera 180°

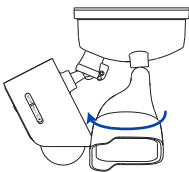

- 3 Rotate lights up

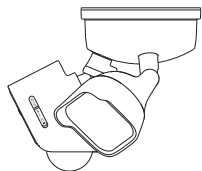

- 4 Tilt lights up

While positioning the camera for an overhang installation, find the "E" and arrows on the joint arm behind the camera. Make sure the arrows are in alignment. **Do not** rotate the camera completely around as this may twist or break the connection line.

- 2 Tilt the camera slightly up so the camera is looking out and the motion sensor is facing out and downward when mounted under an overhang.

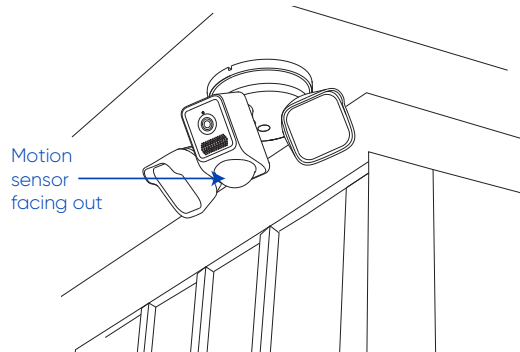

Motion sensor facing out

- 3 Remove your existing floodlight and any brackets that may be attached if you are replacing an older floodlight.

- 4 Place the mounting bracket on the junction box. Align the 2 screw holes and tighten the bracket using matching bracket screws (Bag C, D, or E).

Note: If you don't have a junction box, please find a licensed electrician to install one and follow local building codes.

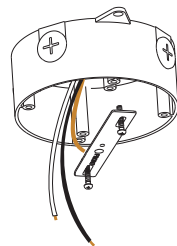

Caution: Do not force the wires on the mounting bracket

Junction Box

- 5 Use the ground wire screw to attach the ground wire to the middle of the mounting bracket (Bag A).

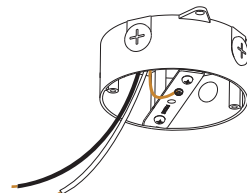

Use the ground screw

Ground wire is usually exposed copper wire or colored green.

- 6 Hang the floodlight on the mounting bracket using the provided hook as shown in the picture.

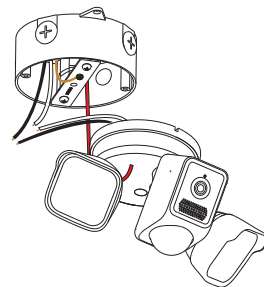

➤ Connect the hot wire (usually black) from your floodlight to the hot wire from your junction box. Then connect the 2 neutral wires (usually white). Cap the wires using wire nuts and twist them 5-10 times. Gently tug on the wire nut to make sure it's securely attached.

IMPORTANT: If you are not sure which wire is which, please consult an electrician for safety.

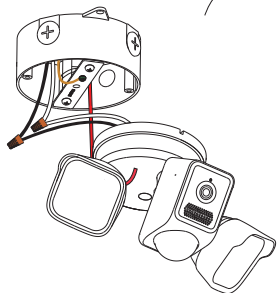
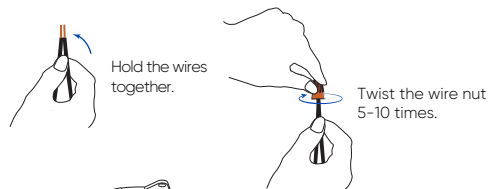

Note: The screw and rubber plug installation steps are the same as 8 and 9 for wall installation.



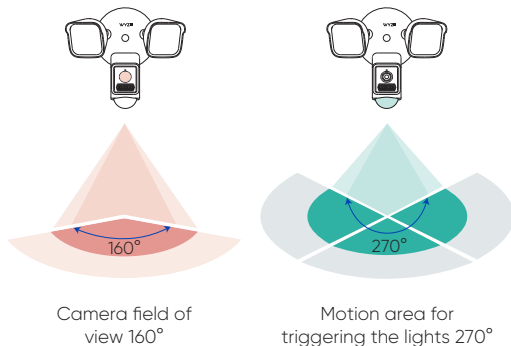

The next steps are the same for both eave and wall mounting.



- Rotate and tilt the floodlight so it points where you want it.
- Restore power to the junction box using the circuit breaker or fuse box. The camera status light should flash red.
- Follow the instructions in the Wyze app to finish setup.

Note: We recommend leaving the ladder in place until after you're done pairing the camera(s) and adjusting the floodlight position.

WYZE CAM FLOODLIGHT V2 STATUS LIGHT GUIDE

-  **Solid red light**
The device is powered on an initializing
-  **Flashing red light**
The device is ready to connect
-  **Flashing red & blue lights**
Connection is in progress
-  **Flashing blue light**
The device is connecting to Wi-Fi
-  **Solid blue light**
The device is working properly

- If you need to reinstall the device after resetting or deleting the device, press the SETUP button on the side of the camera for 3 seconds or until a voice prompt sounds.

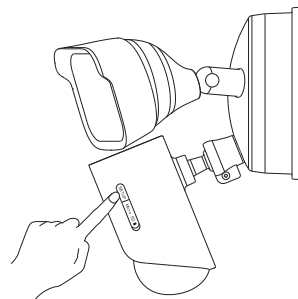

WARRANTY

Your Wyze product is covered by a one-year limited warranty. You can view the limited warranty terms at <https://wyze.com/return-warranty-policy> or request a copy by contacting Wyze at +1 (206) 339-9646.

SPECIFICATIONS

Model: WYZECFL2 WYZECFL2BL

Connectivity: 2.4 GHz Wi-Fi

Weather Resistance: IP65

Input: Hardwired 120V~50/60Hz 0.61A



Apple logo and App Store are trademarks of Apple Inc., registered in the U.S. and other countries and regions. Google Assistant, Google Home, Google Play, and the Google Play logo are trademarks of Google LLC.

Wyze and Wyze Cam Floodlight v2 are trademarks of Wyze Labs, Inc.

FCC WARNING

This device complies with Part 15 of the FCC Rules. Operation is subject to the following two conditions:
(1) This device may not cause harmful interference, and
(2) This device must accept any interference received, including interference that may cause undesired operation.

Caution: The user is cautioned that changes or modifications not expressly approved by the party responsible for compliance could void the user's authority to operate the equipment.

This equipment has been tested and found to comply with the limits for a Class B digital device, pursuant to Part 15 of the FCC Rules. These limits are designed to provide reasonable protection against harmful interference in a residential installation. This equipment generates, uses, and can radiate radio frequency energy and, if not installed and used in accordance with the instructions, may cause harmful interference to radio communications. However, there is no guarantee that interference will not occur in a particular installation. If this equipment does cause harmful interference to radio or television reception, which can be determined by turning the equipment off and on, the user is encouraged to try to correct the interference by one or more of the following measures:

- Reorient or relocate the receiving antenna.
- Increase the separation between the equipment and receiver.
- Connect the equipment into an outlet on a circuit different from that to which the receiver is connected.
- Consult the dealer or an experienced radio/TV technician for help.

RF RADIATION EXPOSURE STATEMENT

This equipment complies with FCC radiation exposure limits set forth for an uncontrolled environment. This equipment should be installed and operated with minimum distance 20cm between the radiator and your body.

SUPPLIER'S DECLARATION OF CONFORMITY

Brand Name: WYZECFL2 WYZECFL2BL

Model Number: WYZECFL2 WYZECFL2BL

Suppliers Name: Wyze Labs, Inc.

Suppliers Address (USA): 5808 Lake Washington Blvd NE
Ste 300 Kirkland WA 98033

Suppliers Phone Number or Internet Contact Information:
1-844-999-3226

ISED RSS WARNING

This device contains licence-exempt transmitter(s)/receiver(s) that comply with Innovation, Science and Economic Development Canada's licence-exempt RSS(s). Operation is subject to the following two conditions: (1) This device may not cause interference and (2) This device must accept any interference, including interference that may cause undesired operation of the device.

AVERTISSEMENT DE L'ISED CONCERNANT LES NORMES RSS

L'émetteur/récepteur exempt de licence contenu dans le présent appareil est conforme aux CNR d'Innovation, Sciences et Développement économique Canada applicables aux appareils radio exempts de licence. L'exploitation est autorisée aux deux conditions suivantes: (1) L'appareil ne doit pas produire de brouillage; (2) L'appareil doit accepter tout brouillage radioélectrique subi, même si le brouillage est susceptible d'en compromettre le fonctionnement.

ISED RADIATION EXPOSURE STATEMENT

This equipment complies with IC RSS-102 radiation exposure limits set forth for an uncontrolled environment. This equipment should be installed and operated with minimum distance 20cm between the radiator and your body.

DÉCLARATION D'EXPOSITION AUX RADIATIONS DE LA L'ISED

Cet équipement est conforme aux limites d'exposition aux radiations IC CNR-102 établies pour un environnement non contrôlé. Cet équipement doit être installé et utilisé avec une distance minimale de 20cm entre le radiateur et votre corps.

NEED HELP?

Contact our Support Team:

<https://wyze.com/support>

Join the Community:

<https://wyze.com/community>



Scan the QR code
to learn more